

ODD ROW

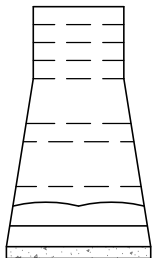

MIDDLE/BASE BLOCK
(24" THROUGH 84")

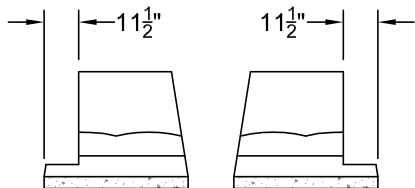

FITTING BLOCK
(24" OR 39" - LEFT OR RIGHT)

EVEN ROW

NOTE: THE MAXIMUM ANGLE OF 118 DEGREES, AS SHOWN, IS BASED UPON A FITTING BLOCK RECESS OF 11.5" (29 CM) FROM THE OUTSIDE OF THE BLOCK. IF A GREATER ANGLE IS REQUIRED, THEN EITHER (A) THE RECESS ON THE FITTING BLOCK MUST BE INCREASED OR (B) SOME LOSS OF RUNNING BOND AT THE OBLIQUE CORNER MUST BE ACCEPTABLE.

© Copyright 2016 ReCon Wall Systems, Inc. All Rights Reserved

Disclaimer: This drawing has been prepared by ReCon Wall Systems, Inc. and to the best of its knowledge, accurately represents the product use in the application that it is illustrated. This drawing is intended for conceptual purposes only. Anyone making use of this drawing does so at their own risk and assumes all liability for such use. Final design for construction purposes must be completed by a Registered Professional Engineer who is familiar with the product and who has taken into account specific site conditions.



DRAWING #201

**OBLIQUE INSIDE
CORNER - STANDARD**

RECON WALL SYSTEMS, INC.
7600 W. 27th STREET, #229
ST. LOUIS PARK, MN 55426
952-922-0027
www.reconwalls.com

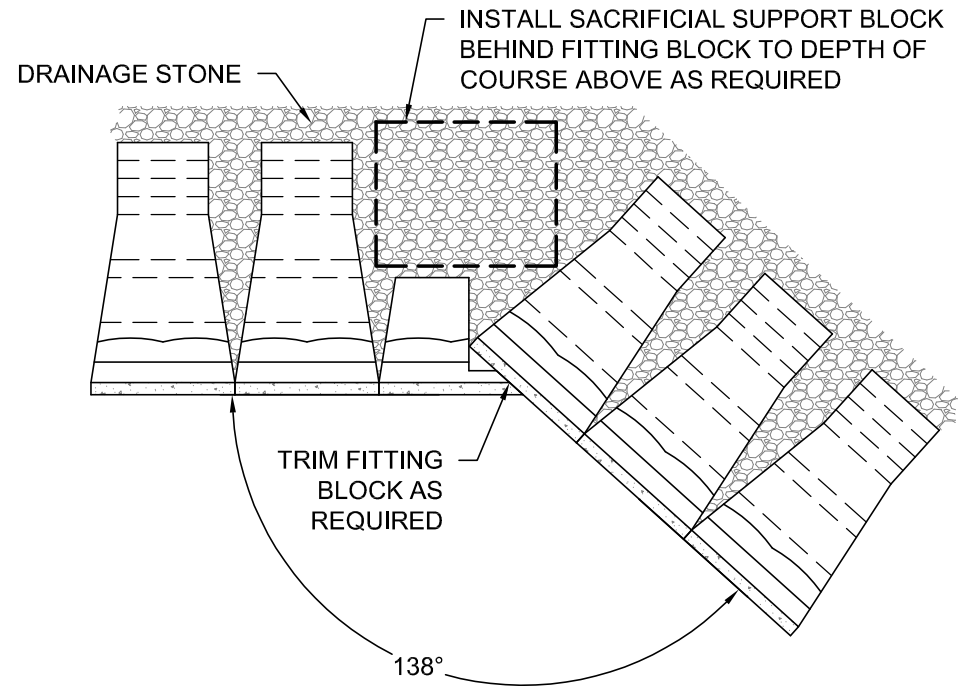
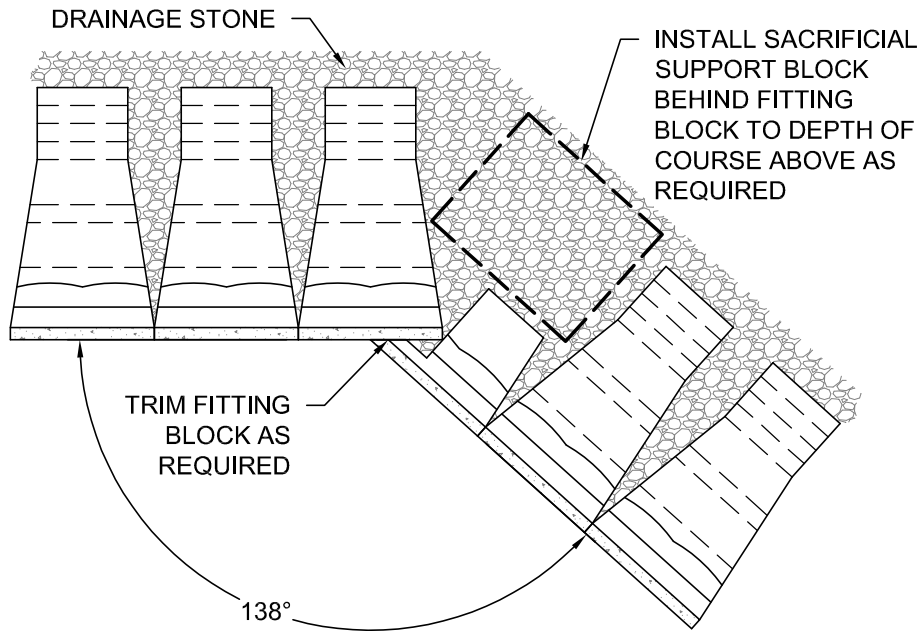

ODD ROW

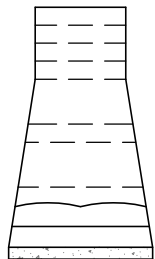

MIDDLE/BASE BLOCK
(24" THROUGH 84")

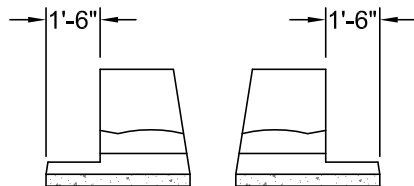

FITTING BLOCK - **SPECIAL**
(24" OR 39" - LEFT OR RIGHT)

EVEN ROW

NOTE: THE MAXIMUM ANGLE OF 138 DEGREES, AS SHOWN, IS BASED UPON A FITTING BLOCK RECESS OF 18" (46 CM) FROM THE OUTSIDE OF THE BLOCK. IF A GREATER ANGLE IS REQUIRED, THEN EITHER (A) THE RECESS ON THE FITTING BLOCK MUST BE INCREASED OR (B) SOME LOSS OF RUNNING BOND AT THE OBLIQUE CORNER MUST BE ACCEPTABLE. CHECK WITH LOCAL RECON PRODUCER FOR AVAILABILITY OF THE SPECIAL FITTING BLOCK.

© Copyright 2016 ReCon Wall Systems, Inc. All Rights Reserved

Disclaimer: This drawing has been prepared by ReCon Wall Systems, Inc. and to the best of its knowledge, accurately represents the product use in the application that it is illustrated. This drawing is intended for conceptual purposes only. Anyone making use of this drawing does so at their own risk and assumes all liability for such use. Final design for construction purposes must be completed by a Registered Professional Engineer who is familiar with the product and who has taken into account specific site conditions.



DRAWING #202

**OBLIQUE INSIDE
CORNER - SPECIAL**

RECON WALL SYSTEMS, INC.
7600 W. 27th STREET, #229
ST. LOUIS PARK, MN 55426
952-922-0027
www.reconwalls.com

INSTALL SACRIFICIAL
SUPPORT BLOCK BEHIND
FITTING BLOCK TO DEPTH OF
COURSE ABOVE AS REQUIRED

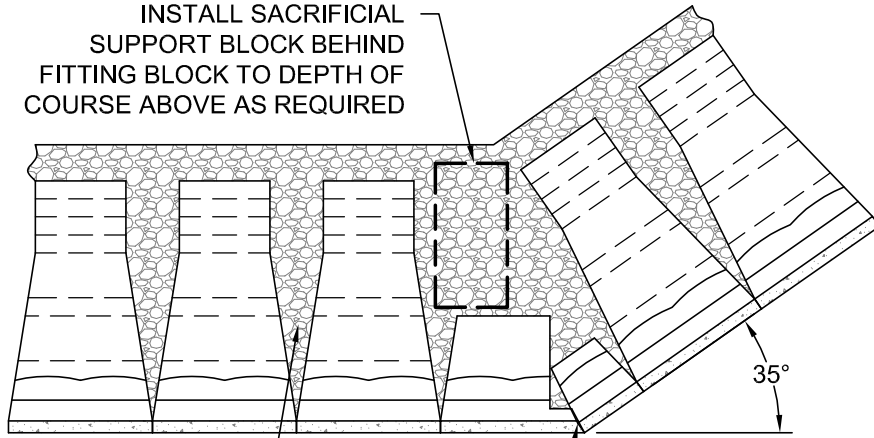

DRAINAGE STONE

TRIM FITTING
BLOCK AS
REQUIRED

35°

INSTALL SACRIFICIAL
SUPPORT BLOCK BEHIND
FITTING BLOCK TO DEPTH OF
COURSE ABOVE AS REQUIRED

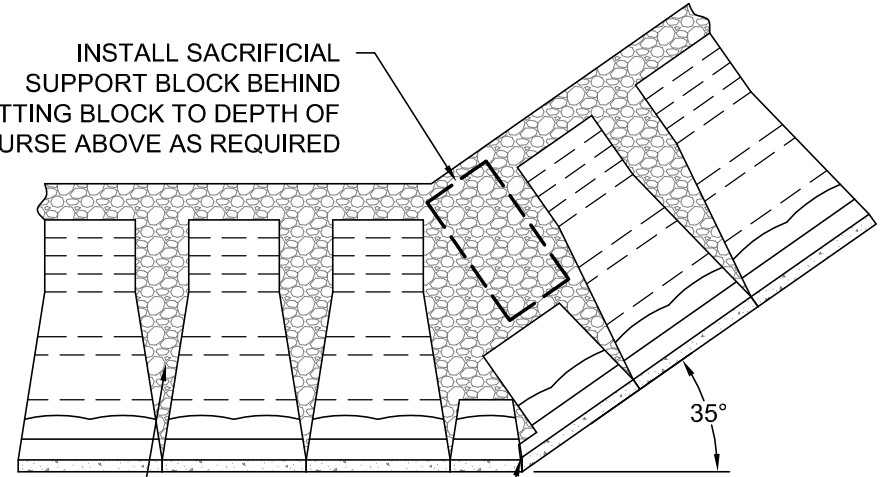

DRAINAGE STONE

TRIM FITTING
BLOCK AS
REQUIRED

35°

ODD ROW

EVEN ROW

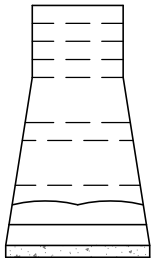

MIDDLE/BASE BLOCK
(24" THROUGH 84")

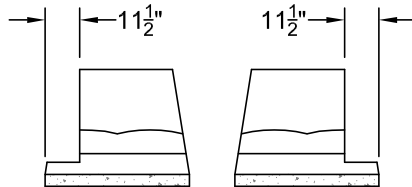

FITTING BLOCK
(24" OR 39" - LEFT OR RIGHT)



24" MIDDLE/BASE
HALF BLOCK
(MAY BE CAST w/o
TONGUE TO AVOID
FIELD CUTTING)

NOTE: THE MAXIMUM ANGLE OF 35 DEGREES, AS SHOWN, IS BASED UPON A FITTING BLOCK RECESS OF 11.5" (29 CM) FROM THE OUTSIDE OF THE BLOCK. IF A GREATER ANGLE IS REQUIRED, THEN EITHER (A) THE RECESS ON THE FITTING BLOCK MUST BE INCREASED OR (B) SOME GAP BETWEEN THE TEXTURES AT THE OBLIQUE CORNER MUST BE ACCEPTABLE.

© Copyright 2016 ReCon Wall Systems, Inc. All Rights Reserved

Disclaimer: This drawing has been prepared by ReCon Wall Systems, Inc. and to the best of its knowledge, accurately represents the product use in the application that it is illustrated. This drawing is intended for conceptual purposes only. Anyone making use of this drawing does so at their own risk and assumes all liability for such use. Final design for construction purposes must be completed by a Registered Professional Engineer who is familiar with the product and who has taken into account specific site conditions.



DRAWING #203

OBLIQUE OUTSIDE
CORNER - STANDARD

RECON WALL SYSTEMS, INC.
7600 W. 27th STREET, #229
ST. LOUIS PARK, MN 55426
952-922-0027
www.reconwalls.com

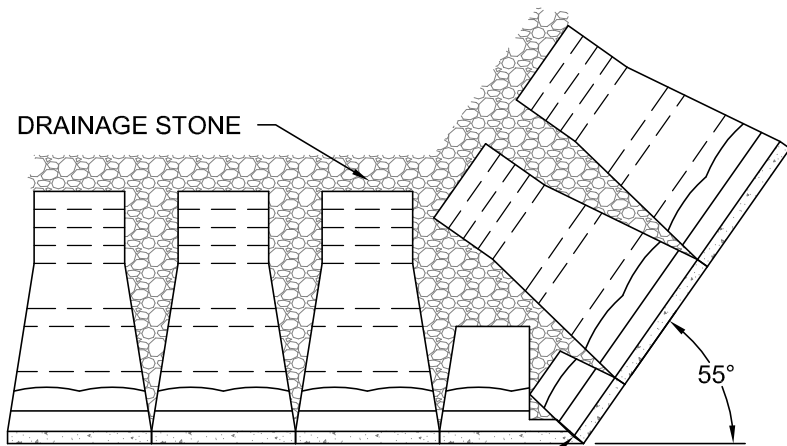

TRIM FITTING
BLOCK AS
REQUIRED

ODD ROW

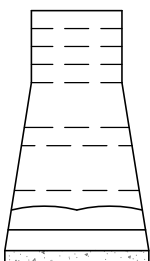

MIDDLE/BASE BLOCK
(24" THROUGH 84")

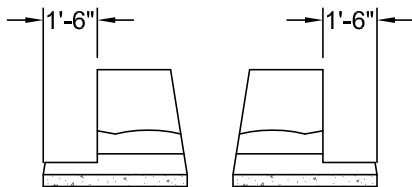

FITTING BLOCK - ***SPECIAL***
(24" OR 39" - LEFT OR RIGHT)



24" MIDDLE/BASE
HALF BLOCK
(MAY BE CAST w/o
TONGUE TO AVOID
FIELD CUTTING)

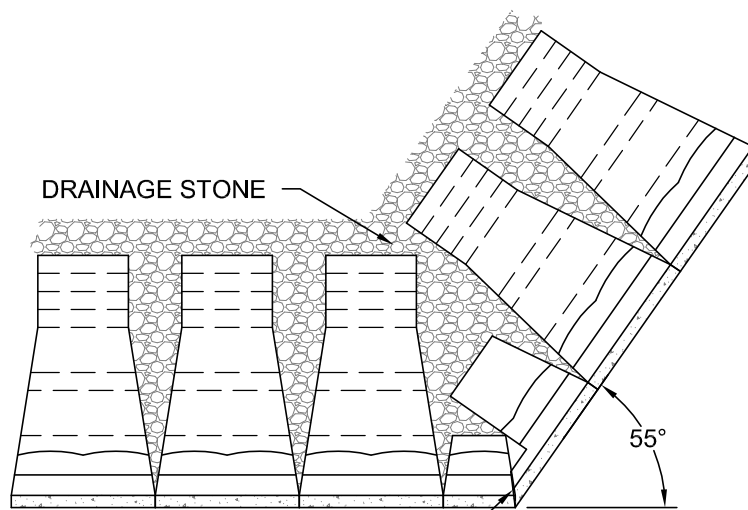

TRIM FITTING
BLOCK AS
REQUIRED

EVEN ROW

NOTE: THE MAXIMUM ANGLE OF 55 DEGREES, AS SHOWN, IS BASED UPON A FITTING BLOCK RECESS OF 18" (46 CM) FROM THE OUTSIDE OF THE BLOCK. IF A GREATER ANGLE IS REQUIRED, THEN EITHER (A) THE RECESS ON THE FITTING BLOCK MUST BE INCREASED OR (B) SOME GAP BETWEEN THE TEXTURES AT THE OBLIQUE CORNER MUST BE ACCEPTABLE. CHECK WITH LOCAL RECON PRODUCER FOR AVAILABILITY OF THE SPECIAL FITTING BLOCK.

© Copyright 2016 ReCon Wall Systems, Inc. All Rights Reserved

Disclaimer: This drawing has been prepared by ReCon Wall Systems, Inc. and to the best of its knowledge, accurately represents the product use in the application that it is illustrated. This drawing is intended for conceptual purposes only. Anyone making use of this drawing does so at their own risk and assumes all liability for such use. Final design for construction purposes must be completed by a Registered Professional Engineer who is familiar with the product and who has taken into account specific site conditions.



DRAWING #204

**OBLIQUE OUTSIDE
CORNER - SPECIAL**

RECON WALL SYSTEMS, INC.
7600 W. 27th STREET, #229
ST. LOUIS PARK, MN 55426
952-922-0027
www.reconwalls.com

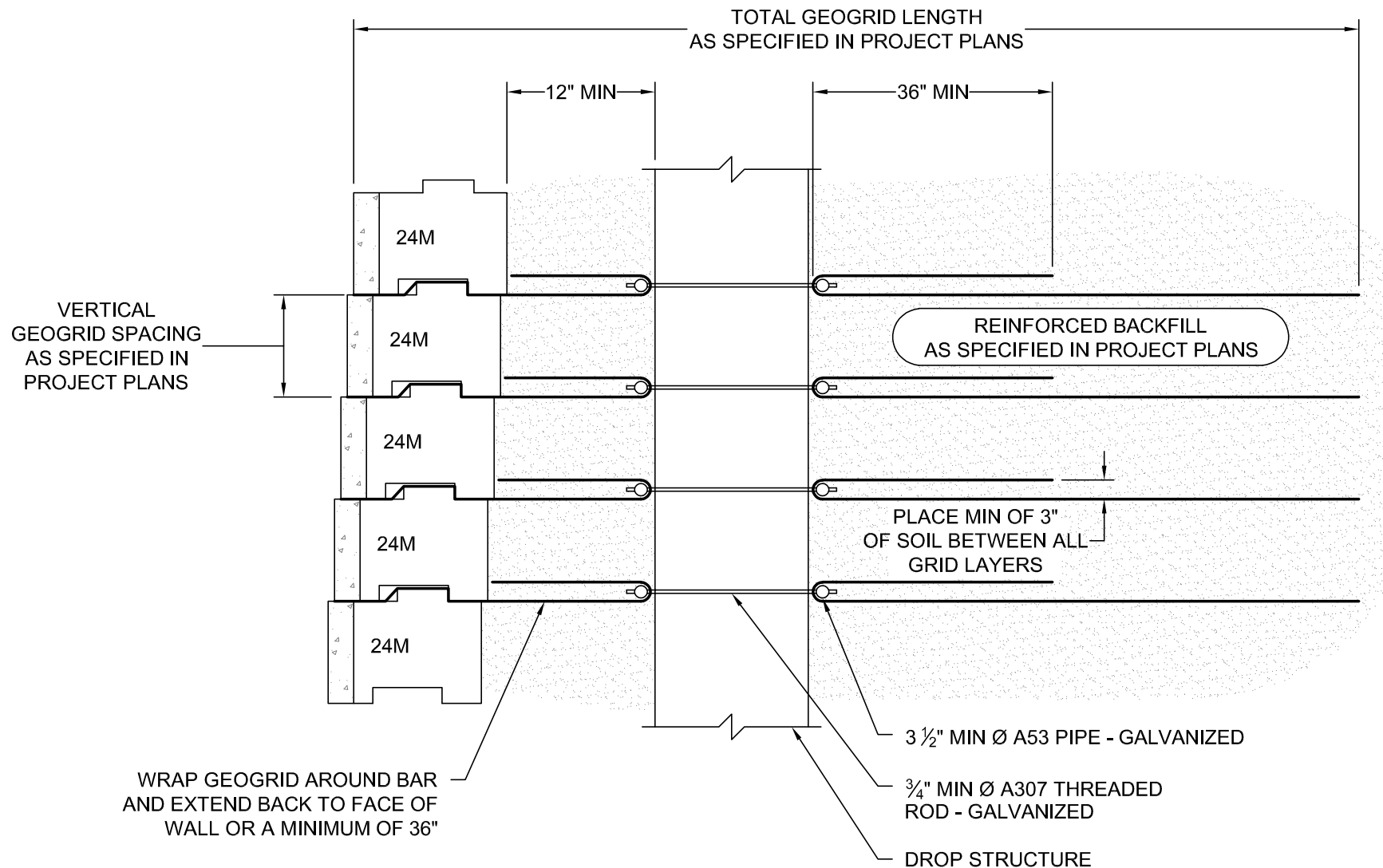

© Copyright 2016 ReCon Wall Systems, Inc. All Rights Reserved

Disclaimer: This drawing has been prepared by ReCon Wall Systems, Inc. and to the best of its knowledge, accurately represents the product use in the application that it is illustrated. This drawing is intended for conceptual purposes only. Anyone making use of this drawing does so at their own risk and assumes all liability for such use. Final design for construction purposes must be completed by a Registered Professional Engineer who is familiar with the product and who has taken into account specific site conditions.

ReConTM
Retaining Walls

DRAWING #205

DROP STRUCTURE THROUGH GRID - SECTION VIEW

RECON WALL SYSTEMS, INC.
7600 W. 27th STREET, #229
ST. LOUIS PARK, MN 55426
952-922-0027
www.reconwalls.com

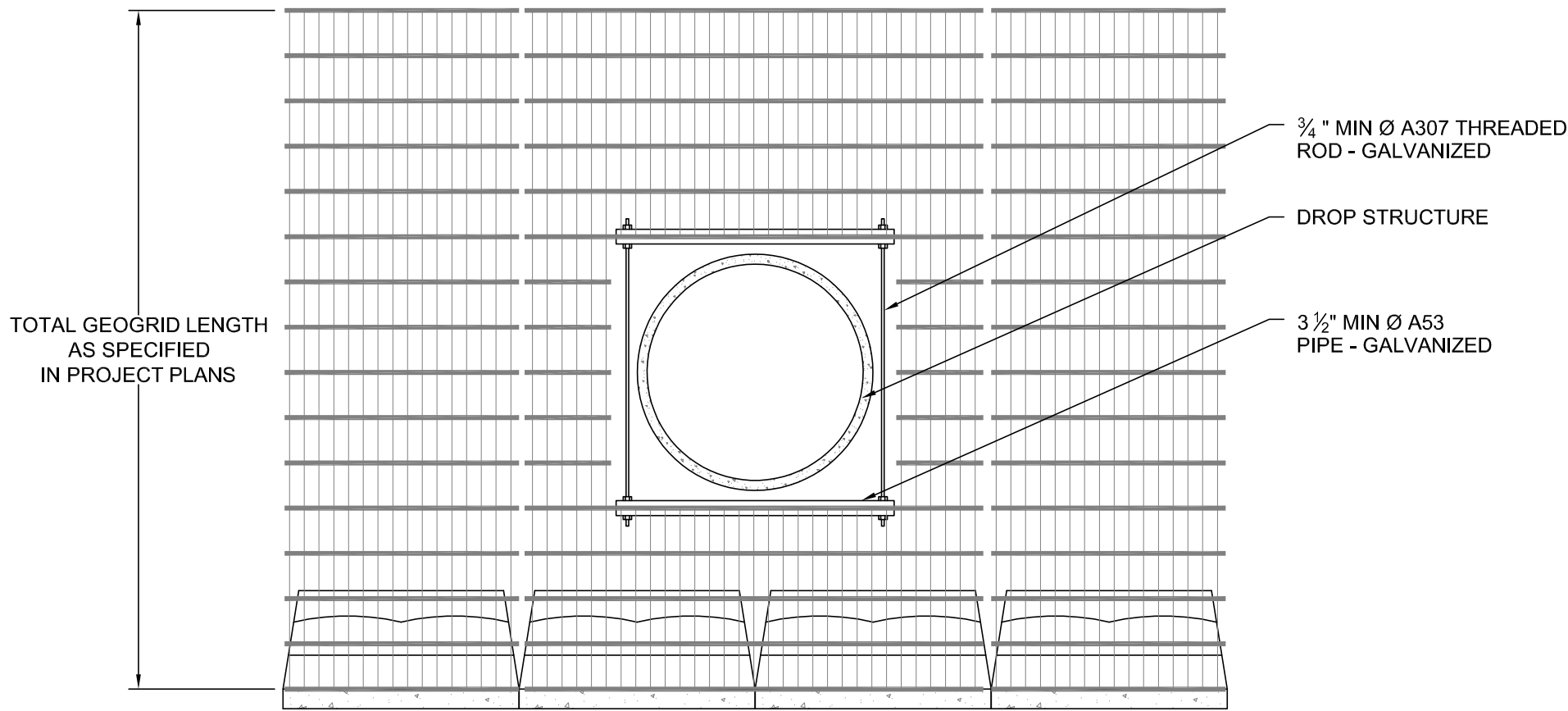

© Copyright 2016 ReCon Wall Systems, Inc. All Rights Reserved

Disclaimer: This drawing has been prepared by ReCon Wall Systems, Inc. and to the best of its knowledge, accurately represents the product use in the application that it is illustrated. This drawing is intended for conceptual purposes only. Anyone making use of this drawing does so at their own risk and assumes all liability for such use. Final design for construction purposes must be completed by a Registered Professional Engineer who is familiar with the product and who has taken into account specific site conditions.



DRAWING #206

**DROP STRUCTURE
THROUGH GRID - PLAN VIEW**

RECON WALL SYSTEMS, INC.
7600 W. 27th STREET, #229
ST. LOUIS PARK, MN 55426
952-922-0027
www.reconwalls.com